



FEMAC 



KANEKO重機

強力粉砕

強力破砕するアタッチメントシリーズ

モデルによって異なりますが、
用途にあわせた刃を選択可能であるため、
多種多様な現場で活躍できる破砕アタッチメント。





T9 REV



T9の動画はこちら!



取り付け 油圧ショベル 2.5T~12T

MAX25cmまで粉碎可能











MZ

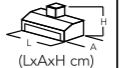

HF3
Ø max8cm
標準装備



KF3
Ø max6cm

| 油圧ショベル | 切断幅 | 寸法 | 重量 | オイル量 | オイル圧 | ベルト(本) | 刃(個数) | |
|--|---|---|---|--|--|---|---|----|
|  (ton) |  (cm) |  (LxAxH cm) |  Kg |  (L/min) |  bar (min-max) |  |  | |
| T9 MZ70 REV | 2.5-4.0 | 70 | 85x80x60 | 180 | 20-30 | 170-220 | 2 | 10 |
| T9 MZ90 REV | 5.0-8.0 | 90 | 105x80x60 | 260 | 40-50-60 | 170-220 | 3 | 14 |
| T9 MZ105 REV | 6.0-12.0 | 105 | 125x80x60 | 310 | 40-50-60 80-90 | 200-220 | 3 | 16 |

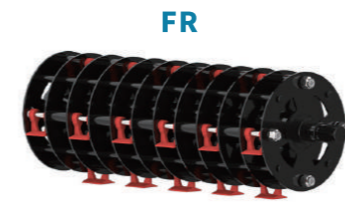

FR









HF7
Ø max12cm



FS

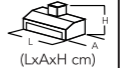

HF8
Ø max12cm

| 油圧ショベル | 切断幅 | 寸法 | 重量 | オイル量 | オイル圧 | ベルト(本) | 刃(個数) | |
|--|---|---|---|--|---|---|---|----|
|  (ton) |  (cm) |  (LxAxH cm) |  Kg |  (L/min) |  bar (min-max) |  |  | |
| T9 FR90 REV | 6.0-8.0 | 90 | 105x80x60 | 300 | 50-60 80-90 | 200-220 | 3 | 18 |
| T9 FS90 REV | 6.0-8.0 | 90 | 105x80x60 | 330 | 50-60 80-90 | 200-220 | 3 | 18 |
| T9 FR105 REV | 6.0-12.0 | 105 | 125x80x60 | 360 | 50-60 80-90 | 200-220 | 3 | 22 |
| T9 FS105 REV | 6.0-12.0 | 105 | 125x80x60 | 400 | 50-60 80-90 | 200-220 | 3 | 22 |











DF



HF14
Ø max25cm
標準装備



HF15
Ø max20cm

| 油圧ショベル | 切断幅 | 寸法 | 重量 | オイル量 | オイル圧 | ベルト(本) | 刃(個数) | |
|---|--|--|--|---|--|--|--|----|
|  (ton) |  (cm) |  (LxAxH cm) |  Kg |  (L/min) |  bar (min-max) |  |  | |
| T9 DF70 REV | 5.0-12.5 | 70 | 85x80x60 | 340 | 22-27-34 44-51 | 200-220 | 3 | 21 |
| T9 DF90 REV | 6.0-12.0 | 90 | 105x80x60 | 400 | 50-60 80-90 | 200-220 | 3 | 24 |
| T9 DF105 REV | 6.0-12.0 | 105 | 105x80x60 | 490 | 50-60 80-90 | 200-220 | 3 | 30 |







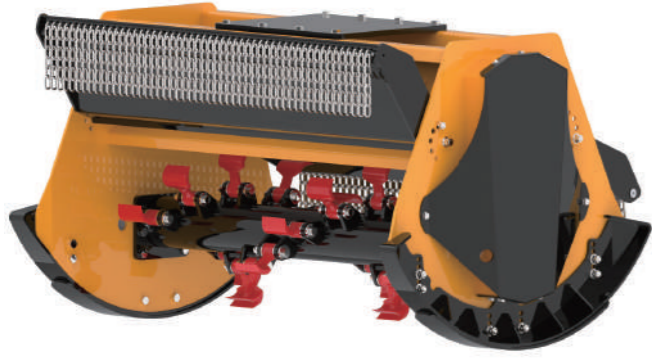





T13 REV









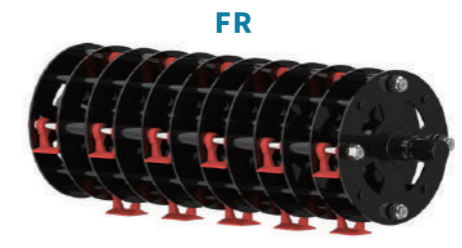

取り付け 油圧ショベル 8T~16T

MAX25cmまで粉碎可能
※ドレーン配管が必要です。











| 油圧ショベル | 切断幅 | 寸法 | 重量 | オイル量 | オイル圧 | ベルト(本) | 刃(個数) | |
|--|---|---|---|--|---|---|---|----|
|  (ton) |  (cm) |  (LxAxH cm) |  Kg |  (L/min) |  bar (min-max) |  |  | |
| T13 MZ105 REV | 8.0-16.0 | 105 | 125x95x85 | 480 | 80-100 | 200-220 | 1 (50 mm) | 16 |
| T13 MZ130 REV | 8.0-16.0 | 130 | 145x95x85 | 540 | 80-100 | 200-220 | 1 (50 mm) | 20 |



| 油圧ショベル | 切断幅 | 寸法 | 重量 | オイル量 | オイル圧 | ベルト(本) | 刃(個数) | |
|--|---|---|---|--|---|---|---|----|
|  (ton) |  (cm) |  (LxAxH cm) |  Kg |  (L/min) |  bar (min-max) |  |  | |
| T13 FR105 REV | 8.0-16.0 | 105 | 125x95x85 | 535 | 80-100 | 200-220 | 1 (50 mm) | 22 |
| T13 FR130 REV | 8.0-16.0 | 130 | 145x95x85 | 595 | 80-100 | 200-220 | 1 (50 mm) | 26 |



| 油圧ショベル | 切断幅 | 寸法 | 重量 | オイル量 | オイル圧 | ベルト(本) | 刃(個数) | |
|--|---|---|---|--|---|---|---|----|
|  (ton) |  (cm) |  (LxAxH cm) |  Kg |  (L/min) |  bar (min-max) |  |  | |
| T13 DF105 REV | 10.0-16.0 | 105 | 125x95x85 | 685 | 80-100 | 200-220 | 1 (50 mm) | 30 |
| T13 DF130 REV | 10.0-16.0 | 130 | 145x95x85 | 745 | 80-100 | 200-220 | 1 (50 mm) | 36 |





T15 REV



T15の動画はこちら!

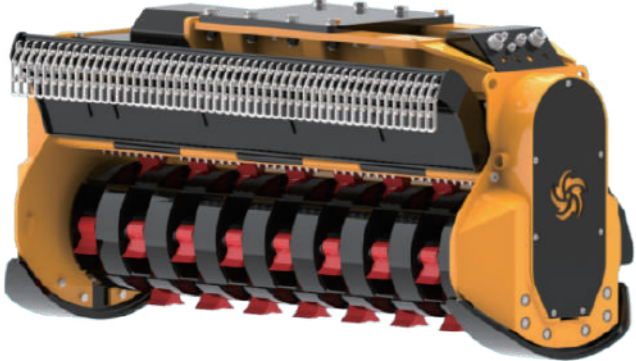

取り付け 油圧ショベル 10T~20T

MAX25cmまで粉碎可能
※ドレーン配管が必要です。



MZ



HF6
Ø max8cm
標準装備



KF7
Ø max6cm

| 油圧ショベル | 切断幅 | 寸法 | 重量 | オイル量 | オイル圧 | ベルト(本) | 刃(個数) |
|---------------|-----------|------|------------|------|---------|---------------|--------------|
| | | | | | | | |
| Modello Model | (ton) | (cm) | (LxAxH cm) | (Kg) | (L/min) | bar (min-max) | |
| T15 MZ130 REV | 10.0-25.0 | 130 | 160x80x85 | 650 | 90-180 | 200-250 | 1 (50 mm) 20 |
| T15 MZ160 REV | 12.0-25.0 | 160 | 190x80x85 | 750 | 90-180 | 200-250 | 1 (50 mm) 20 |

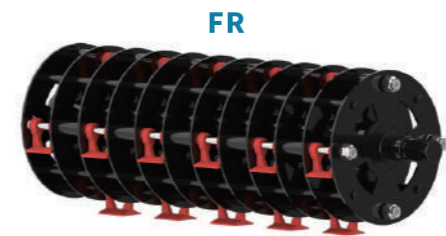

FR



**HF11
HF13**
Ø max25cm
標準装備



**HF10
HF12**
Ø max25cm

| 油圧ショベル | 切断幅 | 寸法 | 重量 | オイル量 | オイル圧 | ベルト(本) | 刃(個数) |
|---------------|-----------|------|------------|------|---------|---------------|--------------|
| | | | | | | | |
| Modello Model | (ton) | (cm) | (LxAxH cm) | (Kg) | (L/min) | bar (min-max) | |
| T15 FR130 REV | 12.0-25.0 | 130 | 160x80x85 | 920 | 90-180 | 200-250 | 1 (50 mm) 26 |
| T15 FR160 REV | 15.0-25.0 | 160 | 190x80x85 | 1020 | 90-180 | 200-250 | 1 (50 mm) 32 |



DF



HF14
Ø max25cm
標準装備



HF15
Ø max20cm

| 油圧ショベル | 切断幅 | 寸法 | 重量 | オイル量 | オイル圧 | ベルト(本) | 刃(個数) |
|---------------|-----------|------|------------|------|---------|---------------|--------------|
| | | | | | | | |
| Modello Model | (ton) | (cm) | (LxAxH cm) | (Kg) | (L/min) | bar (min-max) | |
| T15 DF130 REV | 12.0-25.0 | 130 | 160x80x85 | 950 | 90-180 | 200-250 | 1 (50 mm) 36 |
| T15 DF160 REV | 16.0-25.0 | 160 | 190x80x85 | 1050 | 90-180 | 200-250 | 1 (50 mm) 42 |





T20



T20の動画はこちら!







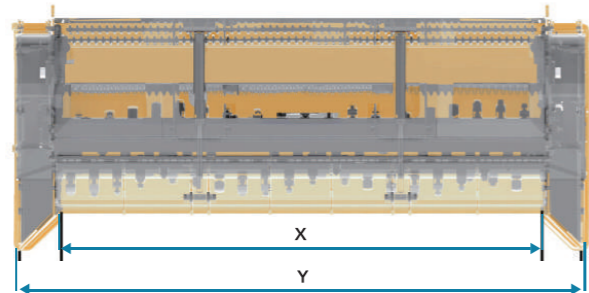
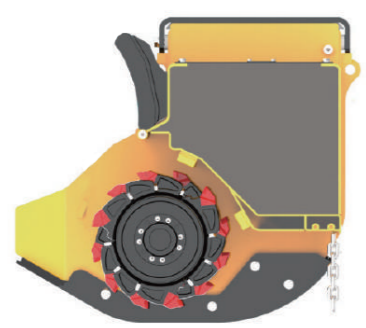

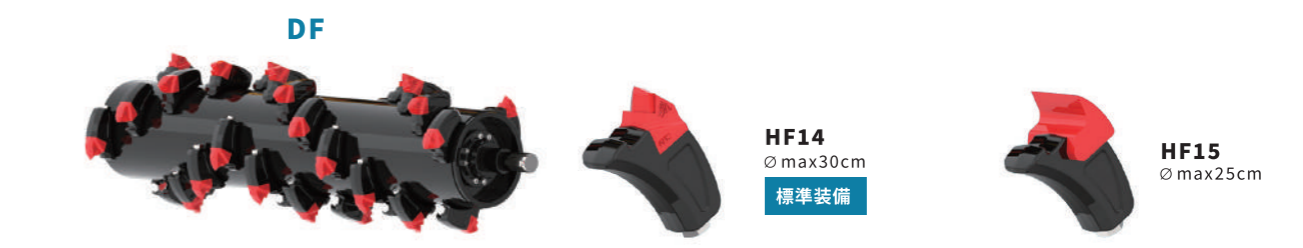

**取り付け 油圧ショベル
16T~30T**

MAX30cmまで粉碎可能
※ドレーン配管が必要です。

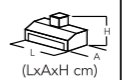

| X | Y |
|------|------|
| 1.30 | 1.60 |
| 1.60 | 1.90 |
| 1.80 | 2.10 |



| | 油圧ショベル | 切断幅 | 寸法 | 重量 | オイル量 | オイル圧 | ベルト(本) | 刃(個数) |
|---------------|--|---|---|---|--|---|---|---|
| Modello Model |  (ton) |  (cm) |  (LxAxH cm) |  Kg |  (L/min) |  bar (min-max) |  |  |
| T20 DF130 | 16.0-30.0 | 130 | 170x100x90 | 1050 | 100-130 180 | 200-350 | 1 (55 mm) | 36 |
| T20 DF160 | 18.0-30.0 | 160 | 200x100x90 | 1185 | 100-130 180 | 200-350 | 1 (55 mm) | 42 |
| T20 DF180 | 20.0-30.0 | 180 | 220x100x90 | 1320 | 100-130 180 | 200-350 | 1 (55 mm) | 54 |





T21 DFX REV



T21の動画はこちら!



取り付け 油圧ショベル 16T~30T









MAX40cmまで粉碎可能
※ドレーン配管が必要です。

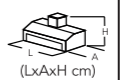

HF20 Ø max 40 cm

標準装備

HF21 Ø max 35 cm

| | 油圧ショベル | 切断幅 | 寸法 | 重量 | オイル量 | オイル圧 | ベルト(本) | 刃(個数) |
|----------------|--|---|---|---|--|---|---|---|
| Modello Model |  (ton) |  (cm) |  (LxAxH cm) |  Kg |  (L/min) |  bar (min-max) |  |  |
| T21 DFX130 REV | 16.0-30.0 | 130 | 170x87x106 | 1300 | 100-130-180 | 200-350 | 1 (55 mm) | 28 |
| T21 DFX160 REV | 18.0-30.0 | 160 | 190x87x106 | 1400 | 100-130-180 | 200-350 | 1 (55 mm) | 32 |





S10の動画はこちら!

S10



スキッドステアローダ / コンパクトトラックローダ

MAX30cmまで粉碎可能

※ドレーン配管が必要です。

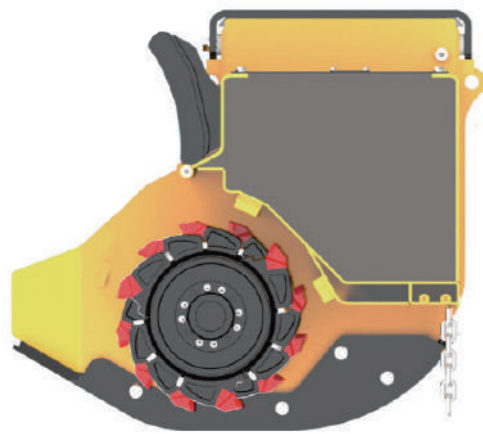

HF14
 Ø max30cm
 標準装備



HF15
 Ø max25cm

| | 油圧ショベル | 切断幅 | 寸法 | 重量 | オイル量 | オイル圧 | ベルト(本) | 刃(個数) |
|---------------|--------|------|-------------|------|----------------|---------------|-----------|-------|
| Modello Model | (ton) | (cm) | (LxAxH cm) | Kg | (L/min) | bar (min-max) | | |
| S10 DF160 | 70-120 | 160 | 200x100x160 | 1285 | 100-130 180 | 200-350 | 1 (55 mm) | 42 |
| S10 DF180 | 70-120 | 180 | 220x100x160 | 1420 | 100-130 180 | 200-350 | 1 (55 mm) | 54 |

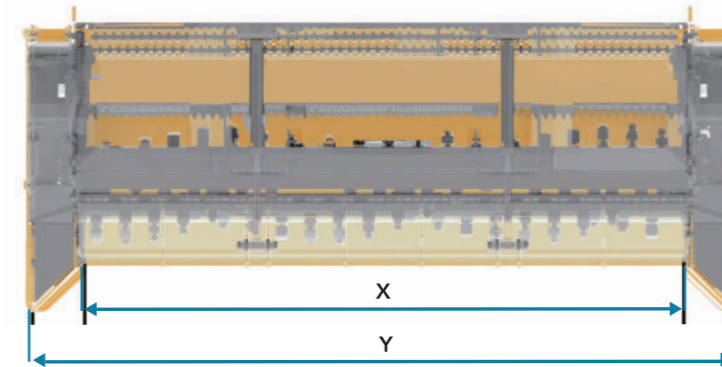

| X | Y |
|------|------|
| 1.60 | 1.90 |
| 1.80 | 2.10 |



KANEKO重機株式会社

〒370-2627 群馬県甘楽郡下仁田町西野牧12080-8

Tel 0274-67-7832 FAX 0274-67-7833



公式HP
<https://kj-juki.com/>

